

Meeting tomorrow's
challenges

Waveguide systems
for aerospace and
defense

Meeting tomorrow's challenges

Amazing in-house manufacturing depth

Thanks to the amazing in-house manufacturing depth of our Teisnach plant, we can offer all processes required for the production of waveguide systems.

Starting with mechanical and electrical design, all production steps from milling to soldering, surface treatment and mechanical or electrical testing are available at one site. This ensures fast processes and an absolute focus on quality. Rohde&Schwarz is fully qualified to manufacture Tesat-Spacecom waveguides.

History

- ▮ JCSat
- ▮ Inmarsat
- ▮ Tesat-Spacecom test laboratories

Rohde & Schwarz and its high-tech plant in Teisnach

Rohde&Schwarz plays an integral role in meeting the challenges that tomorrow will bring. We are one of the world's leading innovators in electronic test and measurement, radiocommunications, radiomonitoring and radiolocation.

The scope and performance of our technologies are second to none.

Aerospace and defense programs rely on the unsurpassed performance and quality of Rohde&Schwarz solutions. We maintain the tight control on quality that only co-located engineering and manufacturing can provide. We also offer a unique level of support.

With facilities in over 70 countries, comprehensive service, and the ability to serve any need including custom solutions and systems, we win not only on performance but also on support.

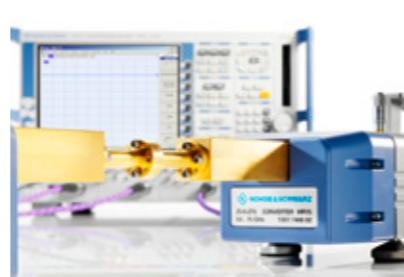
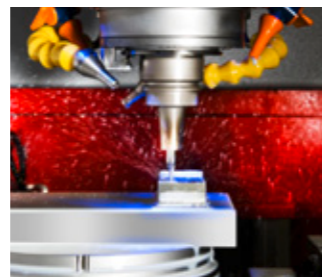
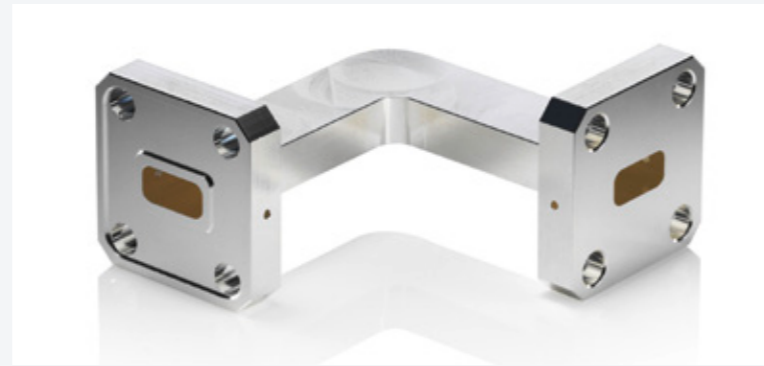

Five steps to your waveguide system

1. Design

We understand the specific needs of the aerospace and defense community, and design our solutions to meet these needs. We use our own mechanical and electrical design departments to implement customer requirements.

Process

- ▮ Customer provision of data sheet and drawing
- ▮ Mechanical design of 3D model
- ▮ Electromagnetic simulation and design of 3D model
- ▮ Development of technical manufacturing concepts

2. Milling

Our waveguides are milled on five-axis DMU 50 evolution milling machines. We use specially designed waveguide and flange profiles or standard aluminum round material.

Some general figures

- ▮ 600 mm maximum outside milling length for straight waveguides
- ▮ 35 mm maximum side length for angles at minimum inside radius of 1.2 mm
- ▮ Waveguide milling for all types ranging from WR28 to WR229

Advantages

- ▮ Design with Rohde&Schwarz standard milling parts
- ▮ Short delivery times and high availability due to standard parts supermarket
- ▮ Reduced testing effort
- ▮ 100 % replications with excellent electrical performance

3. Soldering/brazing

Standard parts are bonded by means of soldering and brazing.

Advantages

- ▮ Tolerance for single parts ± 0.02 mm
- ▮ Soft soldering (soldering) and hard soldering (brazing) in line with AWS C3.7 class A
- ▮ Solution heat treatment and recrystallization of structural conditions

4. Surface

Our waveguides are finished with silver coatings meeting customer requirements to yield extraordinary electrical values. The outside of our waveguides is protected with paint in standard RAL colors.

Advantages

- ▮ Standard specification for electrodeposited coatings of silver with ± 3 μm coating thickness tolerance in line with ASTM-B700
- ▮ Chemical conversion coatings in line with MIL-C-5541E
- ▮ Paint or powder coating

5. Test

All waveguides or parts leaving our premises are produced and tested in line with the highest quality standards. This is ensured by means of extensive test procedures and documentation fulfilling aerospace industry regulations.

Advantages

- ▮ 100 % mechanical tests
- ▮ Electrical testing and dent tuning
- ▮ First article inspection and certificate of conformity

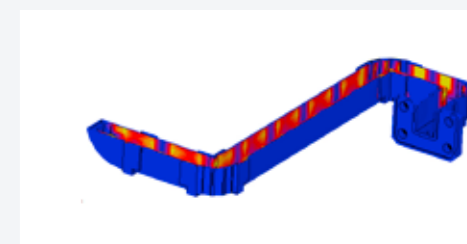
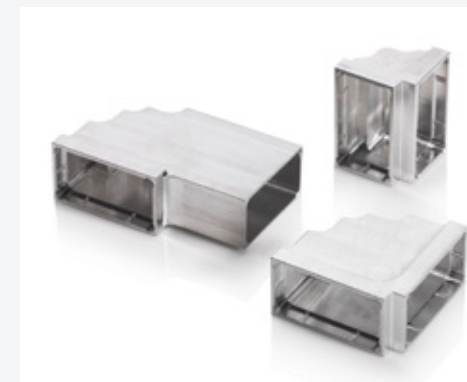
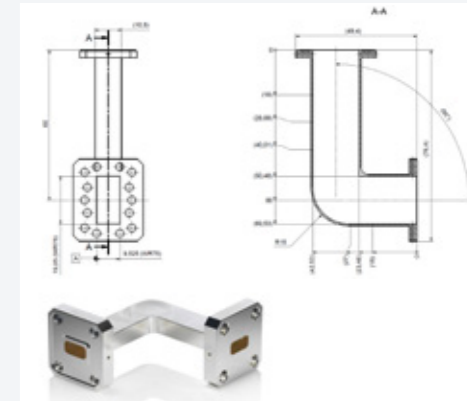

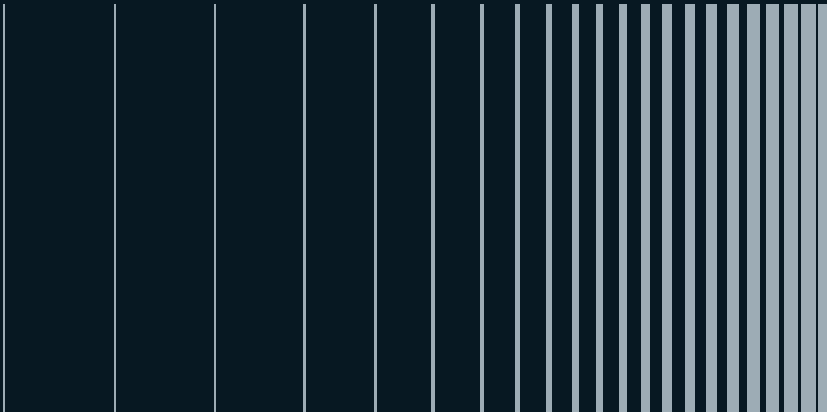

Rohde & Schwarz GmbH & Co. KG

Plant Teisnach

Kaikenrieder Straße 27

94244 Teisnach

Phone +49 9923 85 70

Fax +49 9923 8571 218

Postbox 1149 | 94240 Teisnach

vertrieb.teisnach@rohde-schwarz.com

www.teisnach.rohde-schwarz.com